

InertSustain® C8

InertSustain C8 is an octyl group (C8) bonded column delivering the same extreme inertness to any type of compounds just like InertSustain C18, which enables rapid analysis of highly hydrophobic compounds delivering symmetric peaks at a wide range of pH.

Physical Properties

Silica	: Newly Developed Silica Gel	Bonded Phase	: Octyl Groups
Particle Size	: 3, 5 μm	End-capping	: Complete
Surface Area	: 350 m^2/g	Carbon Loading	: 8 %
Pore Size	: 100 \AA (10 nm)	USP Code	: L7
Pore Volume	: 0.85 mL/g	pH Range	: 1~10

Comparison of Retentivity between InertSustain C18 and C8

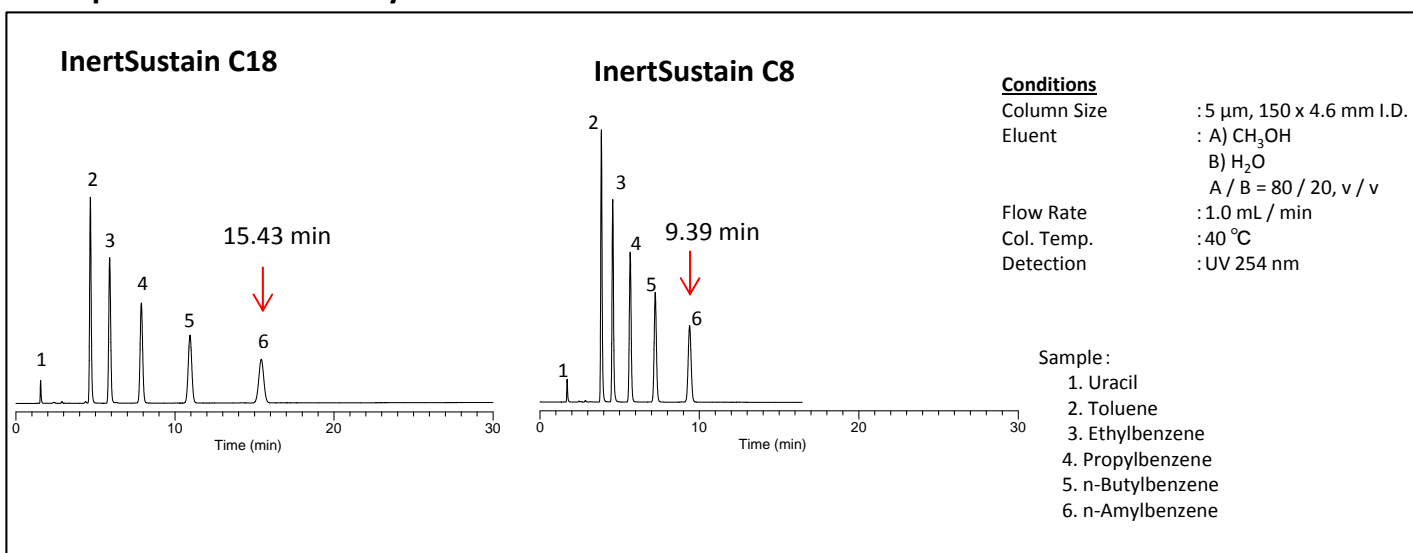

Analysis of Lincomycin under a condition based on the 16th Edition Japanese Pharmacopeia

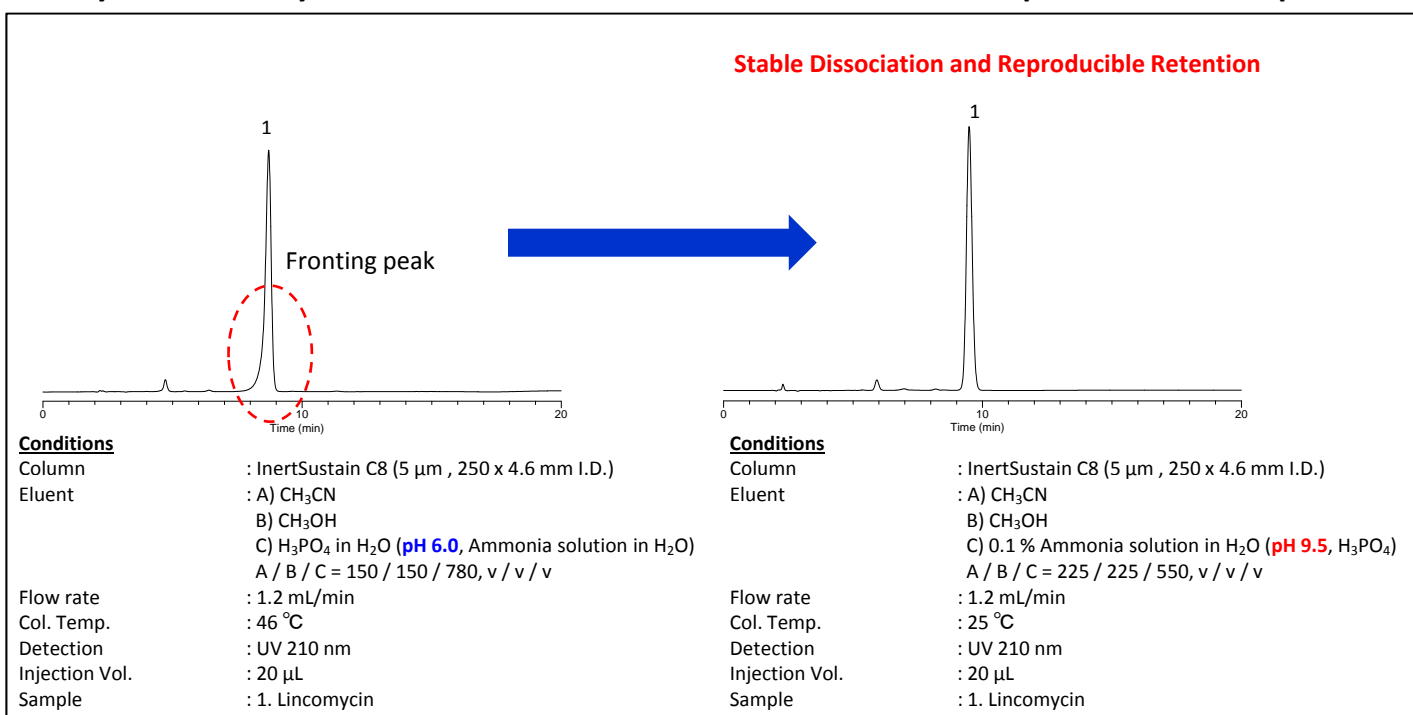

InertSustain[®] Phenyl

InertSustain Phenyl delivers an extremely unique reverse phase characteristics that are critical to resolving compounds that could not be separated on a C18 or C8 phase. InertSustain Phenyl provides not only pi-pi interactions, but also hydrogen bonding secondary interactions, which results in retaining polar compounds at the same time. In addition, InertSustain Phenyl is compatible with the analysis of structural isomers due to its high stereo-selectivity.

Physical Properties

Silica	: Newly Developed Silica Gel	Bonded Phase	: Phenyl Groups
Particle Size	: 3, 5 μm	End-capping	: None
Surface Area	: 350 m^2/g	Carbon Loading	: 10 %
Pore Size	: 100 \AA (10 nm)	USP Code	: L11
Pore Volume	: 0.85 mL/g	pH Range	: 2~7.5

Comparison of Selectivity between InertSustain C18, Phenyl and Other Brands Phenyl column

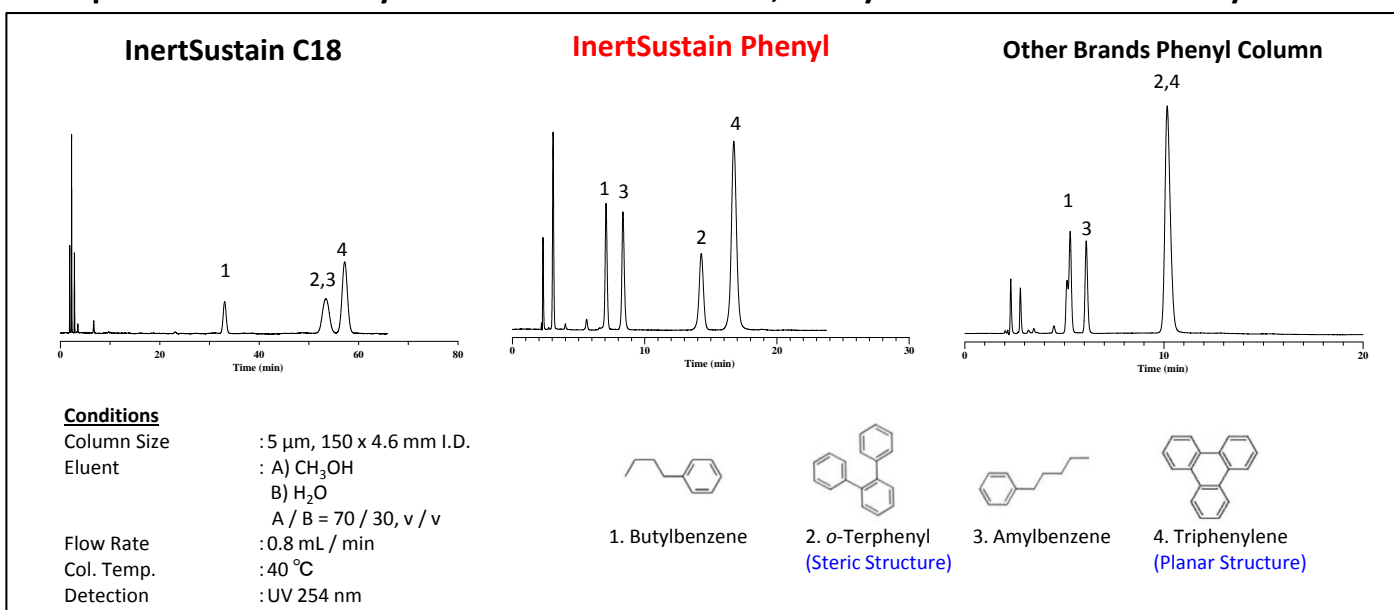

Analysis of Structural Isomers

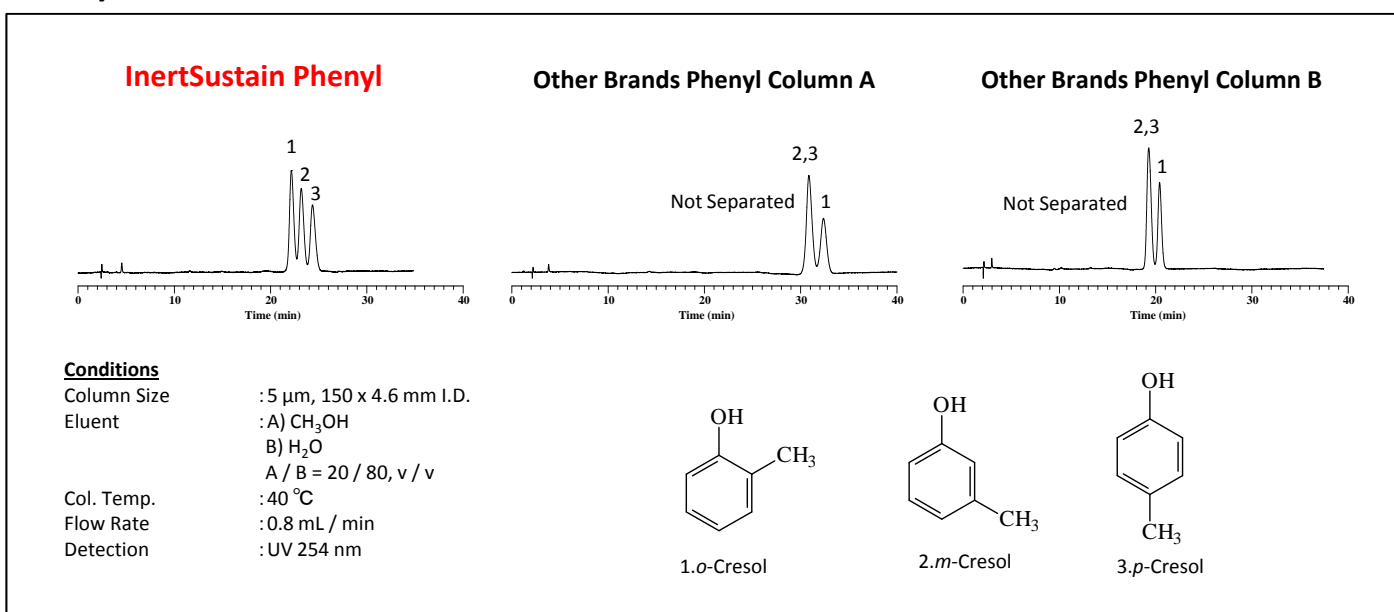

Applications

Phospholipids

Suitable for Highly Lipids

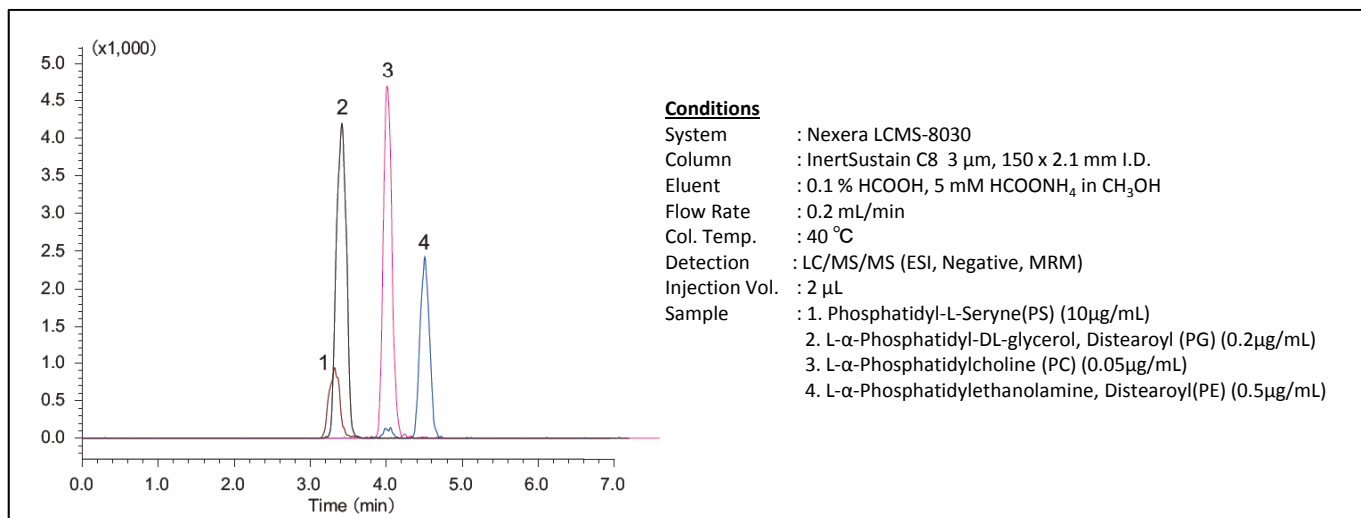

Preservatives, Sweeteners

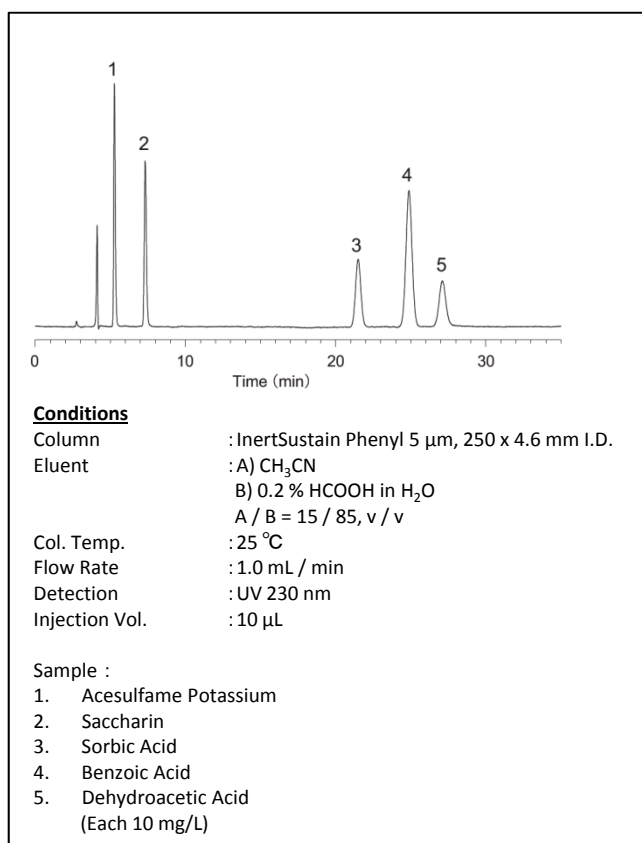

Anti-Inflammatory Drugs

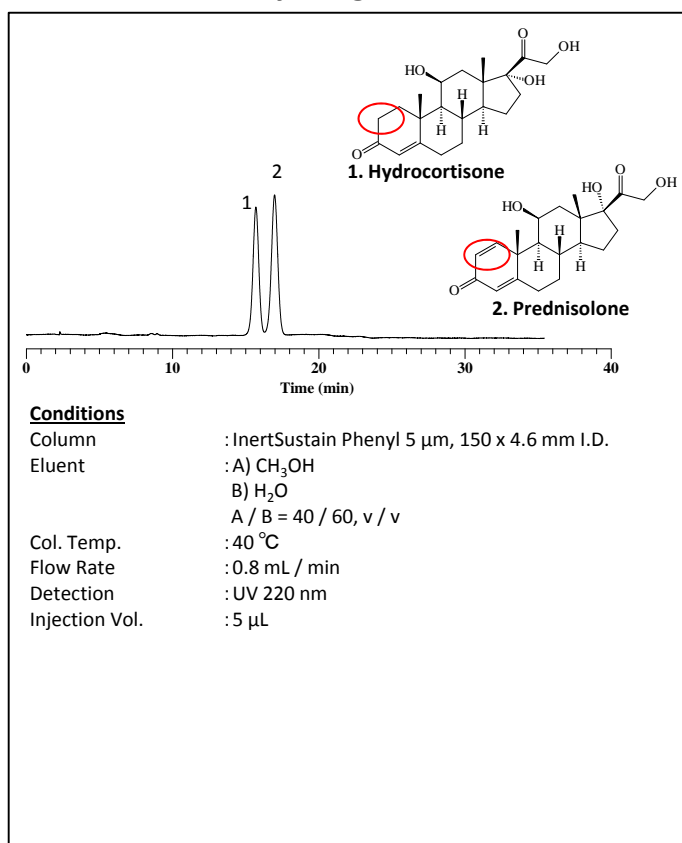

Vitamin E

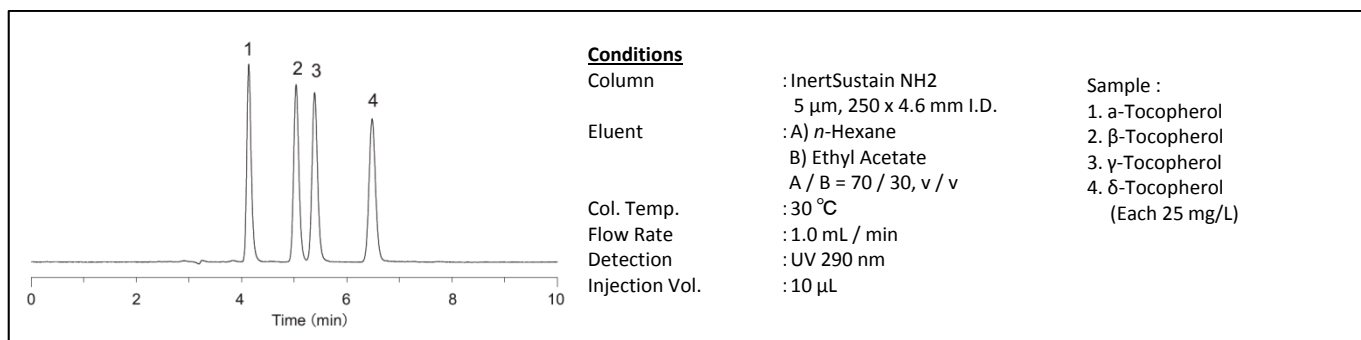

InertSustain C8 Analytical Columns

HP Series Particle Size: 3 µm Max. Operating Pressure: 50 MPa (500 Bar)	Length / I.D. (mm)	2.1	3.0	4.6
	30	5020-16217	5020-16223	5020-16229
	50	5020-16218	5020-16224	5020-16230
	75	5020-16219	5020-16225	5020-16231
	100	5020-16220	5020-16226	5020-16232
	150	5020-16221	5020-16227	5020-16233
	250	5020-16222	5020-16228	5020-16234

※End-fittings are 1/16" Waters-compatible.

※UHPLC compatible end-fittings are also available upon request for UHPLC systems (Ex: UPLC®) to avoid dead volume.

※Indicate "UP Type end-fittings" when ordering. (Please note that UP type is not available for a 4.6 mm I.D. column)

UPLC® is a registered trademark of Waters Corporation.

End-fitting Format

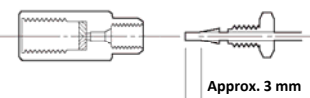

1/16" Waters End-fittings

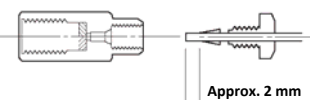

UP Type End-fittings

Particle Size: 3 µm Max. Operating Pressure: 20 MPa (200 Bar)	Length / I.D. (mm)	1.0	1.5		
	30	5020-16168	5020-16174		
	50	5020-16169	5020-16175		
	75	5020-16170	5020-16176		
	100	5020-16171	5020-16177		
	150	5020-16172	5020-16178		
	250	5020-16173	5020-16179		
	Length / I.D. (mm)	2.1	3.0	4.0	4.6
	30	5020-16132	5020-16139	5020-16146	5020-16153
	50	5020-16133	5020-16140	5020-16147	5020-16154
	75	5020-16134	5020-16141	5020-16148	5020-16155
	100	5020-16135	5020-16142	5020-16149	5020-16156
	125	5020-16855	5020-16856	5020-16857	5020-16858
	150	5020-16136	5020-16143	5020-16150	5020-16157
	250	5020-16137	5020-16144	5020-16151	5020-16158

Particle Size: 5 µm Max. Operating Pressure: 20 MPa (200 Bar)	Length / I.D. (mm)	1.0	1.5		
	30	5020-16039	5020-16045		
	50	5020-16040	5020-16046		
	75	5020-16041	5020-16047		
	100	5020-16042	5020-16048		
	150	5020-16043	5020-16049		
	250	5020-16044	5020-16050		
	Length / I.D. (mm)	2.1	3.0	4.0	4.6
	30	5020-16002	5020-16009	5020-16016	5020-16023
	50	5020-16003	5020-16010	5020-16017	5020-16024
	75	5020-16004	5020-16011	5020-16018	5020-16025
	100	5020-16005	5020-16012	5020-16019	5020-16026
	125	5020-16851	5020-16852	5020-16853	5020-16854
	150	5020-16006	5020-16013	5020-16020	5020-16027
	250	5020-16007	5020-16014	5020-16021	5020-16028

※End-fittings are 1/16" Waters-compatible.

※Other column sizes available upon request.

InertSustain C8 Cartridge Guard Columns

I.D. of the Analytical Column Applicable (mm)	Length (mm)	I.D. (mm)	Replacement Cartridge E Guard Column		Cartridge E Holder / Cartridge Set	
			(2 EA.)		(2 Cartridge E Guard Columns & 1 Holder)	
			Particle Size		Particle Size	
			3 µm	5 µm	3 µm	5 µm
1.0	10	1.0	5020-16207	5020-16106	5020-16208	5020-16107
1.5, 2.1		1.5	5020-16209	5020-16108	5020-16210	5020-16109
2.1, 3.0		3.0	5020-16205	5020-16104	5020-16206	5020-16105
4.0, 4.6		4.0	5020-16203	5020-16102	5020-16204	5020-16103
2.1, 3.0	20	3.0	5020-16213	5020-16112	5020-16214	5020-16113
4.0, 4.6		4.0	5020-16211	5020-16110	5020-16212	5020-16111

※Max. Operating Pressure: 30 MPa (300 Bar)

InertSustain C8 Preparative Columns

Particle Size : 5 µm	I.D. (mm)	6.0	7.6	10	14	20
	Length (mm)	Cat.No.	Cat.No.	Cat.No.	Cat.No.	Cat.No.
	50	5020-16055	5020-16059	5020-16063	5020-16067	5020-16071
	100	5020-16056	5020-16060	5020-16064	5020-16068	5020-16072
	150	5020-16057	5020-16061	5020-16065	5020-16069	5020-16073
	250	5020-16058	5020-16062	5020-16066	5020-16070	5020-16074

InertSustain C8 Preparative Guard Columns

Particle Size : 5 µm	I.D. (mm) x Length (mm)	Cat.No
		6.0 X 50 mm
	7.6 X 50 mm	5020-16076
	10 X 50 mm	5020-16077
	14 X 50 mm	5020-16078
	20 X 50 mm	5020-16079

InertSustain C8 Capillary Columns

Capillary EX Columns

Particle Size	Length (mm)	I.D. 0.3mm	I.D. 0.5mm	I.D. 0.7mm
		Cat.No.	Cat.No.	Cat.No.
3 µm	50	5020-16184	5020-16186	5020-16188
	150	5020-16185	5020-16187	5020-16189
5 µm	50	5020-16082	5020-16084	5020-16086
	150	5020-16083	5020-16085	5020-16087
Capillary EX Column Connection Kit			Cat.No.	5020-01880

Capillary EX-Nano Columns

Particle Size	Length (mm)	I.D. 0.05mm	I.D. 0.075mm	I.D. 0.1mm	I.D. 0.2mm
		Cat.No.	Cat.No.	Cat.No.	Cat.No.
3 µm	50	5020-16191	5020-16194	5020-16197	5020-16200
	150	5020-16192	5020-16195	5020-16198	5020-16201
	250	5020-16193	5020-16196	5020-16199	5020-16202
5 µm	50	5020-16090	5020-16093	5020-16096	5020-16099
	150	5020-16091	5020-16094	5020-16097	5020-16100
	250	5020-16092	5020-16095	5020-16098	5020-16101
Capillary EX-Nano Column Connection Kit				Cat.No.	5020-01881

InertSustain Phenyl Analytical Columns

HP Series Particle Size: 3 µm Max. Operating Pressure: 50 MPa (500 Bar)	Length / I.D. (mm)	2.1	3.0	4.6
	30	5020-16517	5020-16523	5020-16529
	50	5020-16518	5020-16524	5020-16530
	75	5020-16519	5020-16525	5020-16531
	100	5020-16520	5020-16526	5020-16532
	150	5020-16521	5020-16527	5020-16533
	250	5020-16522	5020-16528	5020-16534

※End-fittings are 1/16" Waters-compatible.

※UHPLC compatible end-fittings are also available upon request for UHPLC systems (Ex: UPLC®) to avoid dead volume.

※Indicate "UP Type end-fittings" when ordering. (Please note that UP type is not available for a 4.6 mm I.D. column)

UPLC® is a registered trademark of Waters Corporation.

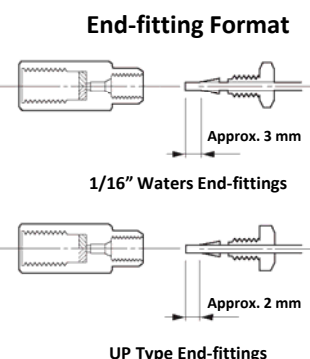

Particle Size: 3 µm Max. Operating Pressure: 20 MPa (200 Bar)	Length / I.D. (mm)	1.0	1.5		
	30	5020-16468	5020-16474		
	50	5020-16469	5020-16475		
	75	5020-16470	5020-16476		
	100	5020-16471	5020-16477		
	150	5020-16472	5020-16478		
	250	5020-16473	5020-16479		
	Length / I.D. (mm)	2.1	3.0	4.0	4.6
	30	5020-16432	5020-16439	5020-16446	5020-16453
	50	5020-16433	5020-16440	5020-16447	5020-16454
	75	5020-16434	5020-16441	5020-16448	5020-16455
	100	5020-16435	5020-16442	5020-16449	5020-16456
	150	5020-16436	5020-16443	5020-16450	5020-16457
	250	5020-16437	5020-16444	5020-16451	5020-16458

Particle Size: 5 µm Max. Operating Pressure: 20 MPa (200 Bar)	Length / I.D. (mm)	1.0	1.5		
	30	5020-16339	5020-16345		
	50	5020-16340	5020-16346		
	75	5020-16341	5020-16347		
	100	5020-16342	5020-16348		
	150	5020-16343	5020-16349		
	250	5020-16344	5020-16350		
	Length / I.D. (mm)	2.1	3.0	4.0	4.6
	30	5020-16302	5020-16309	5020-16316	5020-16323
	50	5020-16303	5020-16310	5020-16317	5020-16324
	75	5020-16304	5020-16311	5020-16318	5020-16325
	100	5020-16305	5020-16312	5020-16319	5020-16326
	150	5020-16306	5020-16313	5020-16320	5020-16327
	250	5020-16307	5020-16314	5020-16321	5020-16328

※End-fittings are 1/16" Waters-compatible.

※Other column sizes available upon request.

InertSustain Phenyl Cartridge Guard Columns

I.D. of the Analytical Column Applicable (mm)	Length (mm)	I.D. (mm)	Replacement Cartridge E Guard Column		Cartridge E Holder / Cartridge Set	
			(2 EA.)		(2 Cartridge E Guard Columns & 1 Holder)	
			Particle Size		Particle Size	
			3 µm	5 µm	3 µm	5 µm
1.0	10	1.0	5020-16507	5020-16406	5020-16508	5020-16407
1.5, 2.1		1.5	5020-16509	5020-16408	5020-16510	5020-16409
2.1, 3.0		3.0	5020-16505	5020-16404	5020-16506	5020-16405
4.0, 4.6		4.0	5020-16503	5020-16402	5020-16504	5020-16403
2.1, 3.0	20	3.0	5020-16513	5020-16412	5020-16514	5020-16413
4.0, 4.6		4.0	5020-16511	5020-16410	5020-16512	5020-16411

※Max. Operating Pressure: 30 MPa (300 Bar)

InertSustain Phenyl Preparative Columns

Particle Size : 5 µm	I.D. (mm)	6.0	7.6	10	14	20
	Length (mm)	Cat.No.	Cat.No.	Cat.No.	Cat.No.	Cat.No.
	50	5020-16355	5020-16359	5020-16363	5020-16367	5020-16371
	100	5020-16356	5020-16360	5020-16364	5020-16368	5020-16372
	150	5020-16357	5020-16361	5020-16365	5020-16369	5020-16373
	250	5020-16358	5020-16362	5020-16366	5020-16370	5020-16374

InertSustain Phenyl Preparative Guard Columns

Particle Size : 5 µm	I.D. (mm) x Length (mm)	Cat.No
	6.0 X 50 mm	5020-16375
	7.6 X 50 mm	5020-16376
	10 X 50 mm	5020-16377
	14 X 50 mm	5020-16378
	20 X 50 mm	5020-16379

InertSustain Phenyl Capillary Columns

Capillary EX Columns

Particle Size	Length (mm)	I.D. 0.3mm	I.D. 0.5mm	I.D. 0.7mm
		Cat.No.	Cat.No.	Cat.No.
3 µm	50	5020-16484	5020-16486	5020-16488
	150	5020-16485	5020-16487	5020-16489
5 µm	50	5020-16382	5020-16384	5020-16386
	150	5020-16383	5020-16385	5020-16387
Capillary EX Column Connection Kit			Cat.No.	5020-01880

Capillary EX-Nano Columns

Particle Size	Length (mm)	I.D. 0.05mm	I.D. 0.075mm	I.D. 0.1mm	I.D. 0.2mm
		Cat.No.	Cat.No.	Cat.No.	Cat.No.
3 µm	50	5020-16491	5020-16494	5020-16497	5020-16500
	150	5020-16492	5020-16495	5020-16498	5020-16501
	250	5020-16493	5020-16496	5020-16499	5020-16502
5 µm	50	5020-16390	5020-16393	5020-16396	5020-16399
	150	5020-16391	5020-16394	5020-16397	5020-16400
	250	5020-16392	5020-16395	5020-16398	5020-16401
Capillary EX-Nano Column Connection Kit				Cat.No.	5020-01881

InertSustain NH2 Analytical Columns

Particle Size: 3 μm Max. Operating Pressure: 20 MPa (200 Bar)	Length / I.D. (mm)	1.0	1.5			
	30	5020-16768	5020-16774			
	50	5020-16769	5020-16775			
	75	5020-16770	5020-16776			
	100	5020-16771	5020-16777			
	150	5020-16772	5020-16778			
	250	5020-16773	5020-16779			
	Length / I.D. (mm)	2.1	3.0	4.0	4.6	
	30	5020-16732	5020-16739	5020-16746	5020-16753	
	50	5020-16733	5020-16740	5020-16747	5020-16754	
	75	5020-16734	5020-16741	5020-16748	5020-16755	
	100	5020-16735	5020-16742	5020-16749	5020-16756	
	150	5020-16736	5020-16743	5020-16750	5020-16757	
	250	5020-16737	5020-16744	5020-16751	5020-16758	

Particle Size: 5 μm Max. Operating Pressure: 20 MPa (200 Bar)	Length / I.D. (mm)	1.0	1.5			
	30	5020-16639	5020-16645			
	50	5020-16640	5020-16646			
	75	5020-16641	5020-16647			
	100	5020-16642	5020-16648			
	150	5020-16643	5020-16649			
	250	5020-16644	5020-16650			
	Length / I.D. (mm)	2.1	3.0	4.0	4.6	
	30	5020-16602	5020-16609	5020-16616	5020-16623	
	50	5020-16603	5020-16610	5020-16617	5020-16624	
	75	5020-16604	5020-16611	5020-16618	5020-16625	
	100	5020-16605	5020-16612	5020-16619	5020-16626	
	150	5020-16606	5020-16613	5020-16620	5020-16627	
	250	5020-16607	5020-16614	5020-16621	5020-16628	

※End-fittings are 1/16" Waters-compatible.
 ※Other column sizes available upon request.

InertSustain NH2 Cartridge Guard Columns

I.D. of the Analytical Column Applicable (mm)	Length (mm)	I.D. (mm)	Replacement Cartridge E Guard Column		Cartridge E Holder / Cartridge Set	
			(2 EA.)		(2 Cartridge E Guard Columns & 1 Holder)	
			Particle Size		Particle Size	
			3 μ m	5 μ m	3 μ m	5 μ m
1.0	10	1.0	5020-16807	5020-16706	5020-16808	5020-16707
1.5, 2.1		1.5	5020-16809	5020-16708	5020-16810	5020-16709
2.1, 3.0		3.0	5020-16805	5020-16704	5020-16806	5020-16705
4.0, 4.6		4.0	5020-16803	5020-16702	5020-16804	5020-16703
2.1, 3.0	20	3.0	5020-16813	5020-16712	5020-16814	5020-16713
4.0, 4.6		4.0	5020-16811	5020-16710	5020-16812	5020-16711

※Max. Operating Pressure: 30 MPa (300 Bar)

InertSustain NH2 Preparative Columns

Particle Size : 5 µm	I.D. (mm)	6.0	7.6	10	14	20
	Length (mm)	Cat.No.	Cat.No.	Cat.No.	Cat.No.	Cat.No.
	50	5020-16655	5020-16659	5020-16663	5020-16667	5020-16671
	100	5020-16656	5020-16660	5020-16664	5020-16668	5020-16672
	150	5020-16657	5020-16661	5020-16665	5020-16669	5020-16673
	250	5020-16658	5020-16662	5020-16666	5020-16670	5020-16674

InertSustain NH2 Preparative Guard Columns

Particle Size : 5 µm	I.D. (mm) x Length (mm)	Cat.No
		6.0 X 50 mm
	7.6 X 50 mm	5020-16676
	10 X 50 mm	5020-16677
	14 X 50 mm	5020-16678
	20 X 50 mm	5020-16679

InertSustain NH2 Capillary Columns

Capillary EX Columns

Particle Size	Length (mm)	I.D. 0.3mm	I.D. 0.5mm	I.D. 0.7mm
		Cat.No.	Cat.No.	Cat.No.
3 µm	50	5020-16784	5020-16786	5020-16788
	150	5020-16785	5020-16787	5020-16789
5 µm	50	5020-16682	5020-16684	5020-16686
	150	5020-16683	5020-16685	5020-16687
Capillary EX Column Connection Kit			Cat.No.	5020-01880

Capillary EX-Nano Columns

Particle Size	Length (mm)	I.D. 0.05mm	I.D. 0.075mm	I.D. 0.1mm	I.D. 0.2mm
		Cat.No.	Cat.No.	Cat.No.	Cat.No.
3 µm	50	5020-16791	5020-16794	5020-16797	5020-16800
	150	5020-16792	5020-16795	5020-16798	5020-16801
	250	5020-16793	5020-16796	5020-16799	5020-16802
5 µm	50	5020-16690	5020-16693	5020-16696	5020-16699
	150	5020-16691	5020-16694	5020-16697	5020-16700
	250	5020-16692	5020-16695	5020-16698	5020-16701
Capillary EX-Nano Column Connection Kit				Cat.No.	5020-01881

Contact Information



GL Sciences, Inc. Japan

22-1 Nishishinjuku 6-Chome
Shinjuku-ku, Tokyo, 163-1130, Japan
Phone: +81-3-5323-6620
FAX: +81-3-5323-6621
email: world@glsc.jp

GL Sciences, Inc. USA

4733 Torrance Blvd. Suite 255
Torrance, CA 90503
Phone: 310-265-4424
FAX: 310-265-4425
email: info@glsciencesinc.com

International Distributors

Visit our Website at
<http://www.glsciences.com/products/contact.html>